

迈斯维5G 组合天线 2X2 MIMO 5G, 2X2 MIMO WiFi 7

AN_Master_Cubic_2C2W-LP

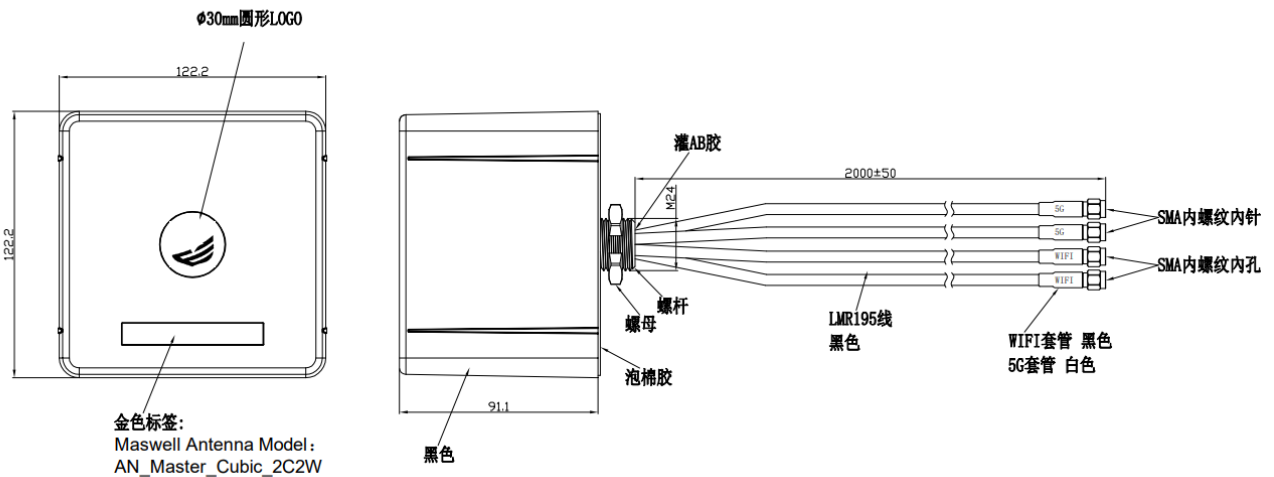

示意图



迈斯维5G 组合天线 2X2 MIMO 5G, 2X2 MIMO WiFi 7

AN_Master_Cubic_2C2W-LP

规格

项目	规格	
天线 1: 5G/4G LTE/WiFi6E/UWB	频率范围	600MHz~8.0GHz
	极化	线极化
	增益	6.0dBi @20cm 电缆长度
	V.S.W.R	平均3.0
	效率	> 50%
天线 2: 5G/4G LTE/WiFi6E/UWB	频率范围	600MHz~8.0GHz
	极化	线极化
	增益	6.0dBi @20cm 电缆长度
	V.S.W.R	平均3.0
	效率	> 50%
天线 3: WiFi	中心频率	2100Mhz-7200MHz
	极化	线性
	增益	4dBi
	V.S.W.R	< 1.5
	阻抗	50Ω
天线 4: WiFi	中心频率	2100Mhz-7200MHz
	极化	线性
	增益	4dBi
	V.S.W.R	< 1.5
	阻抗	50Ω

迈斯维5G 组合天线 2X2 MIMO 5G, 2X2 MIMO WiFi 7

AN_Master_Cubic_2C2W-LP

规格

项目	规格	
机械指标	尺寸	121mm *121mm*91mm
	电缆	LMR195 2米或者定制长度
	安装方式	支架报杆 或者 支架靠墙
	连接头	5G: SMA 公头 (内螺纹内针) WiFi: RP SMA Male (内螺纹无针)
环境参数	工作温度	-40°C~+85°C
	相对湿度	高达95%
	防水等级	IP67
	震动指标	10 to 55Hz 和1.5mm 振幅 2小时测试
	环保指标	符合ROHS

迈斯维5G 组合天线 2X2 MIMO 5G, 2X2 MIMO WiFi 7

AN_Master_Cubic_2C2W-LP

5G S11反射系数

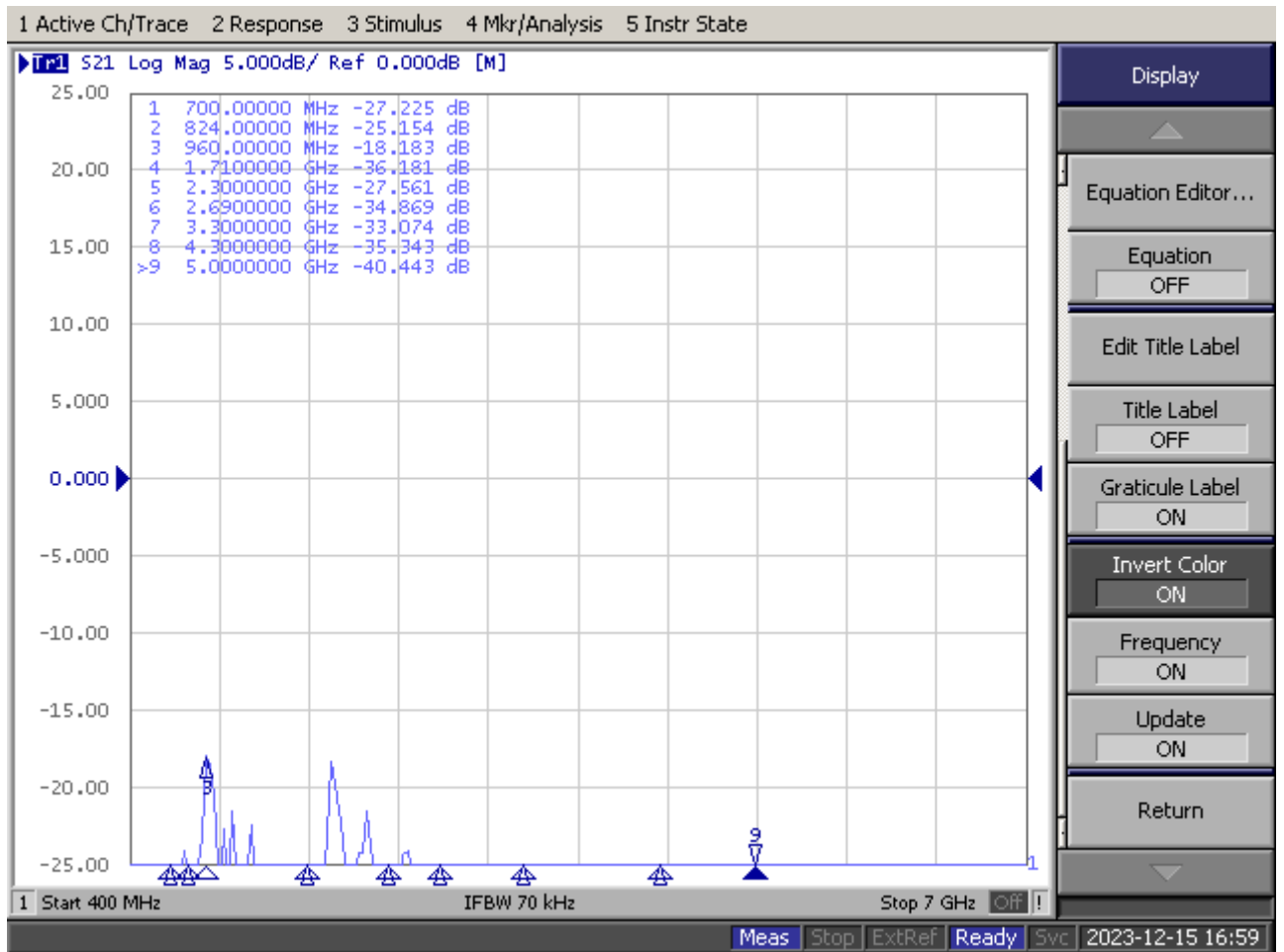

迈斯维5G 组合天线 2X2 MIMO 5G, 2X2 MIMO WiFi 7

AN_Master_Cubic_2C2W-LP

WiFi 7/WiFi 6E S11反射系数

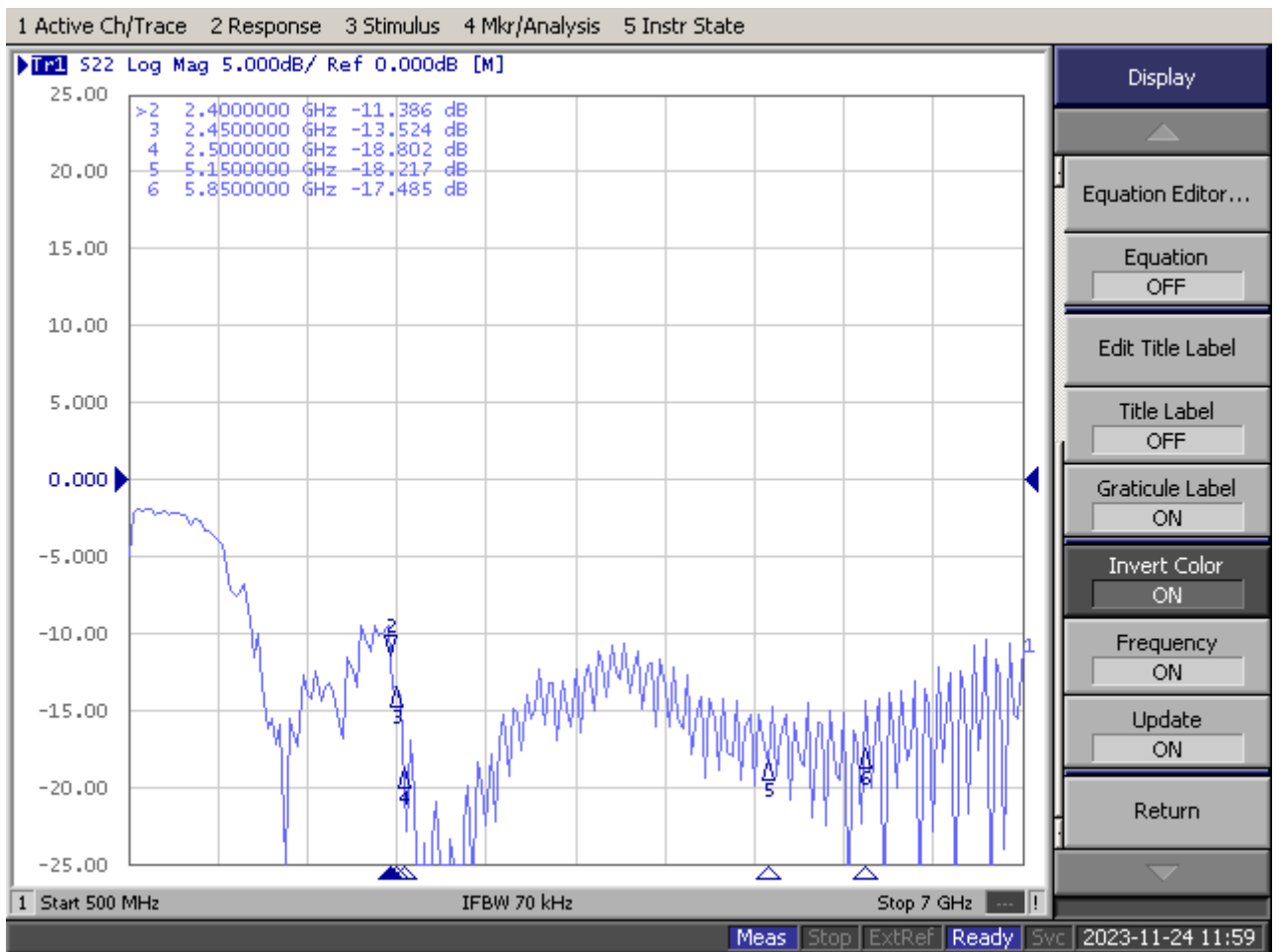

迈斯维5G 组合天线 2X2 MIMO 5G, 2X2 MIMO WiFi 7

AN_Master_Cubic_2C2W-LP

隔离度

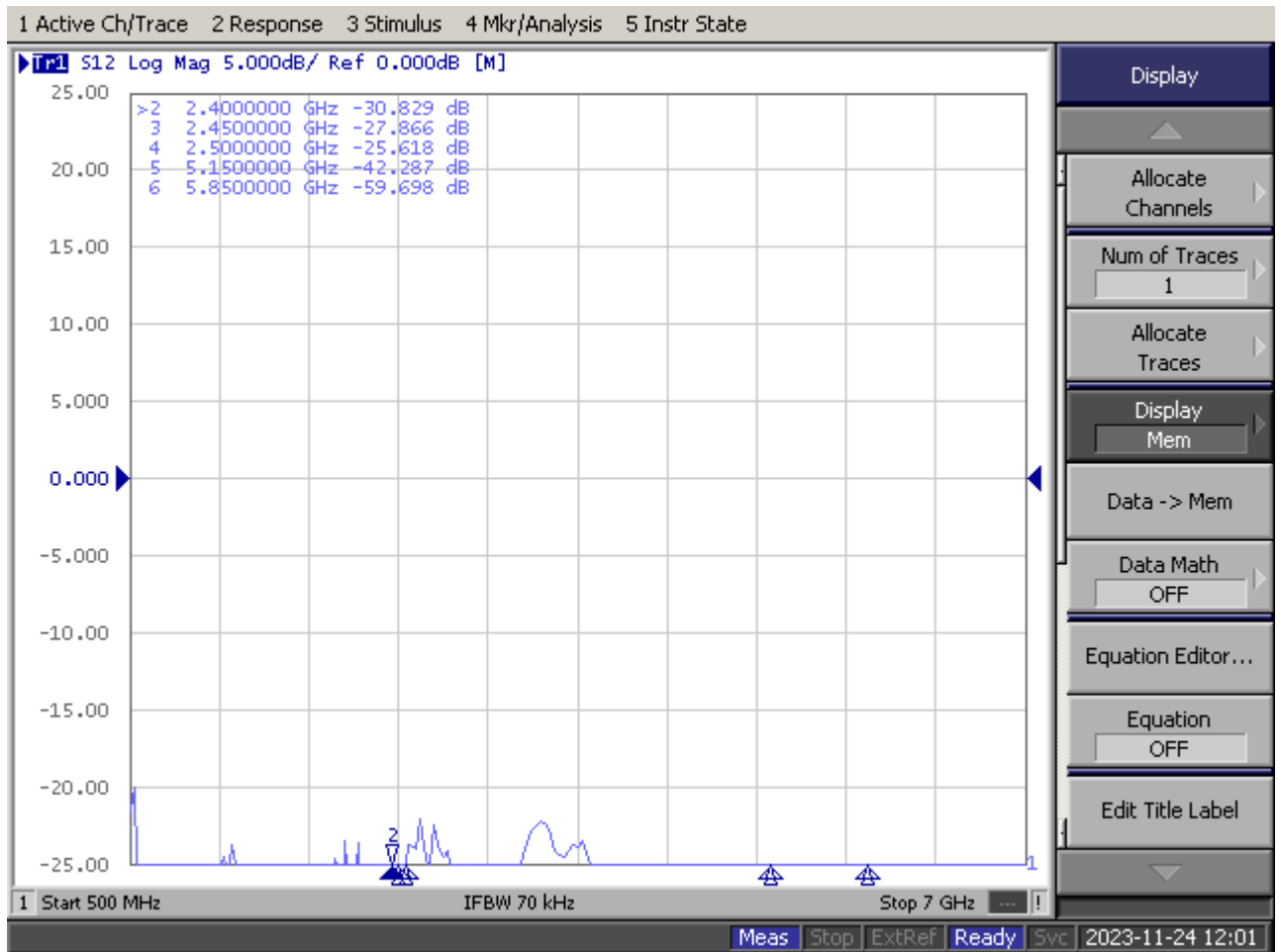

迈斯维5G 组合天线 2X2 MIMO 5G, 2X2 MIMO WiFi 7

AN_Master_Cubic_2C2W-LP

辐射方向图
900MHz

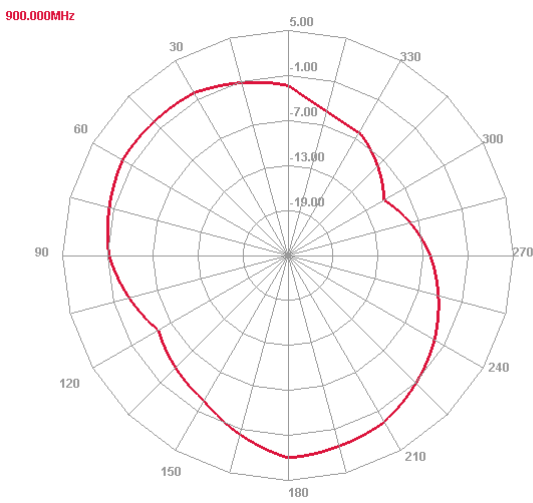

E plane

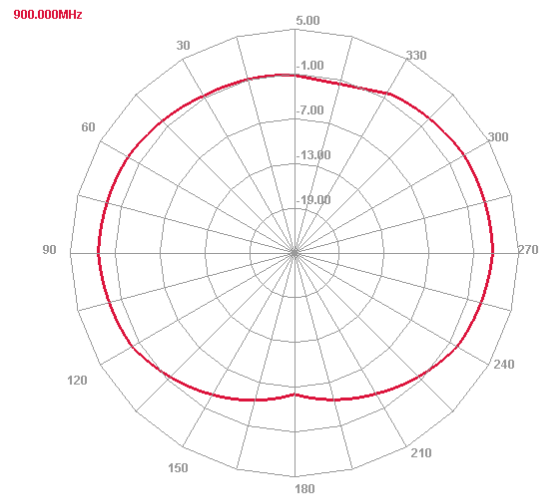

H plane

2400MHz

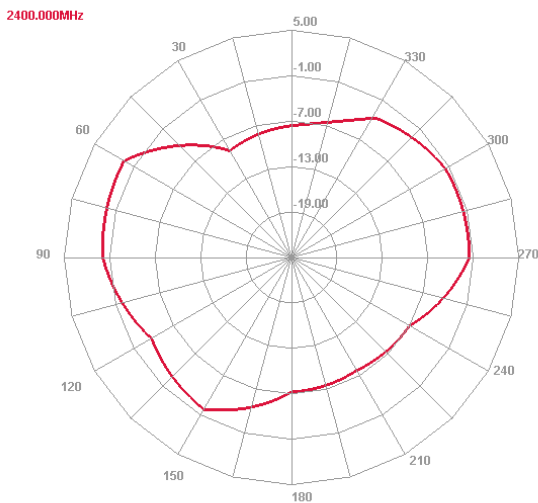

E plane

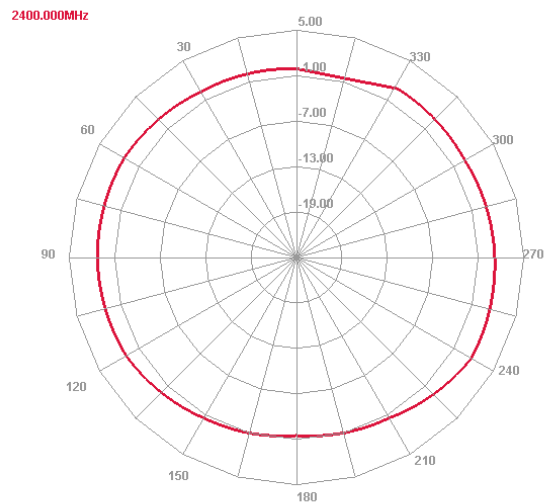

H plane

迈斯维5G 组合天线 2X2 MIMO 5G, 2X2 MIMO WiFi 7

AN_Master_Cubic_2C2W-LP

辐射方向图
3500MHz

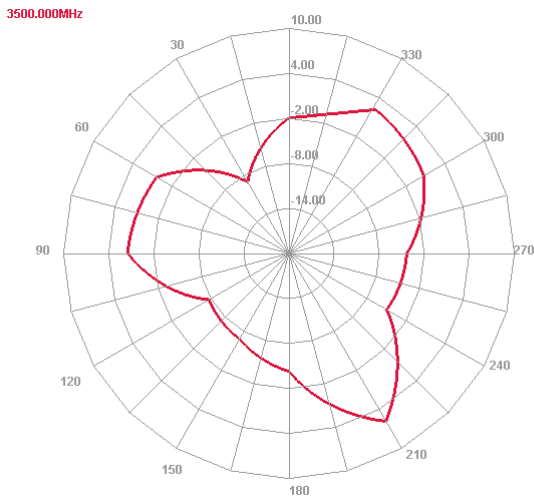

E plane

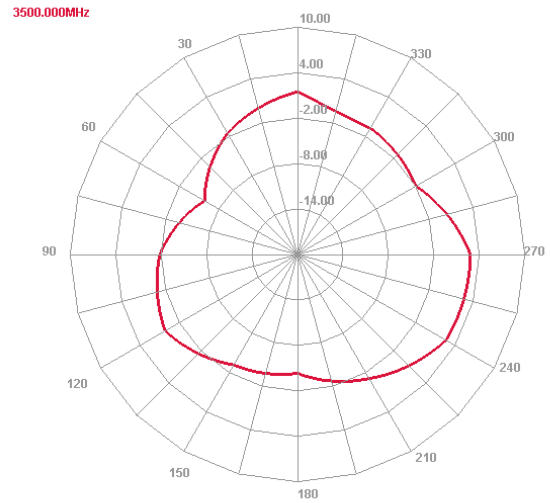

H plane

7100MHz

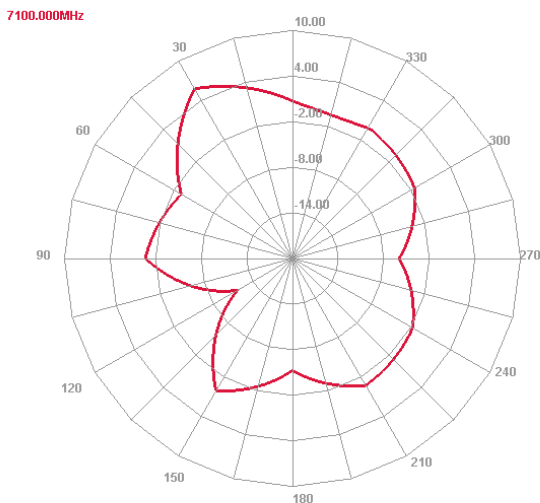

E plane

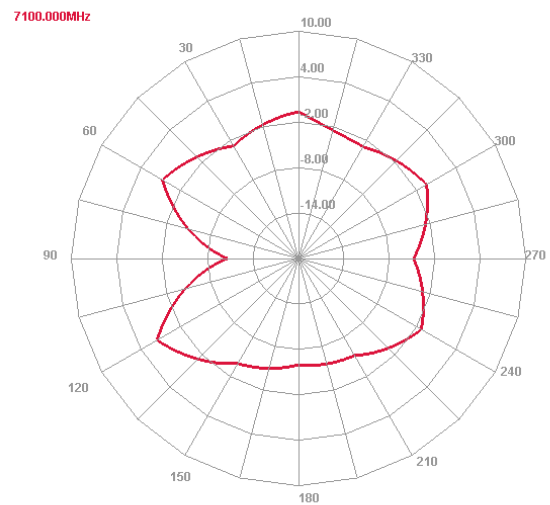

H plane